

N20011 | STEEL

N20012 | ALU

EVOS RAIL KIT

A + R

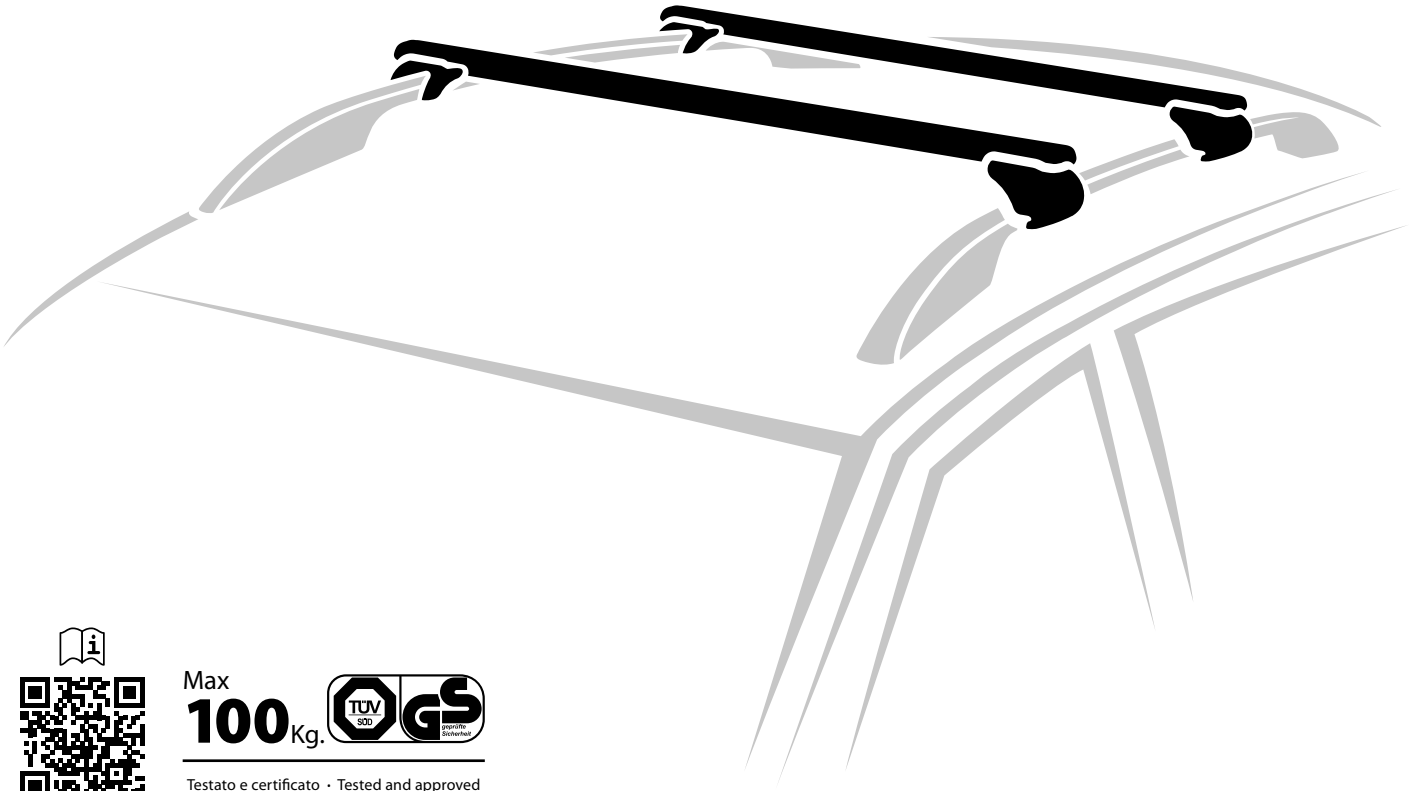

Max
100 Kg.



Testato e certificato · Tested and approved
Geprüft und zertifiziert

I Istruzioni
di montaggio

EN Fitting instructions

F Instructions
de montage

D Montageanleitung

E Instrucciones
de montaje

P Instruções
de montagem

NL Montage-
instructies

S Monteringsanvi-
sning

FIN Asennusohje

EST Paigaldusjuhend

LAT Stiprināšanas
instrukcija

LT Pritvirtinimo
instrukcijos

PL Instrukcja montażu

RUS Инструкции по
установке

CZ Návod na montáž

SK Návod na montáž

SLO Navodila
za pritrjevanje

HR Uputa
za sastavljanje

H A felszerelés módja

GR Οδηγίες
συναρμολόγησης

TR Montaj talimatları

BG Инструкции
за монтаж

SRB Uputstva
za montažu



Safety Regulations

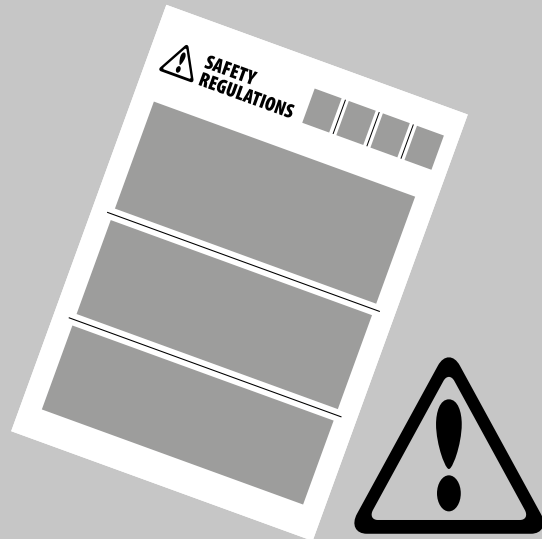
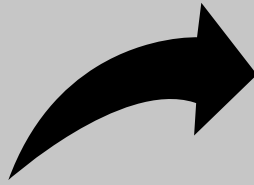

- I** Leggere il libretto di sicurezza e garanzia incluso nel prodotto prima dell'uso. Per maggiori informazioni visita il sito **www.nordrive.it** o contattare direttamente il rivenditore locale.
- EN** Before using this product, please read the enclosed safety and warranty booklet. For more information please visit **www.nordrive.it** or contact your local dealer.
- F** Avant d'utiliser ce produit, veuillez lire le livret de sécurité et de garantie inclus. Pour plus d'informations, visitez le site **www.nordrive.it** ou contactez votre revendeur local.
- D** Bevor die Verwendung des Produkts, die Sicherheitsbrochure und Garantieheft lesen. Für weitere Informationen empfehlen wir Ihnen die Webseite **www.nordrive.it** zu besuchen oder direkt den örtlichen Wiederkäufer zu kontaktieren.
- E** Antes de usar este producto, lea el folleto de seguridad y garantía incluido. Para obtener más información, visite **www.nordrive.it** o póngase en contacto con su distribuidor local.
- P** Antes de usar este produto, por favor leia o livro de segurança e garantia incluso. Para obter mais informações, visite **www.nordrive.it** ou entre em contato com seu revendedor local.
- NL** Lees voor het gebruik van dit product het bijgevoegde veiligheids- en garantieboekje. Ga voor meer informatie naar **www.nordrive.it** neem contact op met uw lokale dealer.
- S** Före användning av denna produkt, vänligen läs den medföljande broschyren om säkerhet och garantivillkor. För mer information vänligen besök **www.nordrive.it** eller kontakta er lokala återförsäljare.
- FIN** Ennen kuin käytät tätä tuotetta, lue mukana toimitettu turva- ja takuukirja. Lisätietoja on osoitteessa **www.nordrive.it** tai ota yhteys paikalliseen jälleenmyyjään.
- EST** Enne toote kasutamist tutvuge kaasasoleva ohutus- ja garantiijuhendiga. Lisateabe saamiseks külastage veebisaiti **www.nordrive.it** või pöörduge kohaliku edasimüüja poole.
- LAT** Pirms šī produkta izmantošanas, lūdzu, izlasiet pievienoto drošības un garantijas bukletu. Lai iegūtu vairāk informācijas, lūdzu, apmeklējiet vietni **www.nordrive.it** vai sazinieties ar vietējo izplatītāju.
- LT** Prieš pradėdant naudoti šį produktą, prašome perskaityti pridėtus saugos ir garantinius lapus. Daugiau informacijos rasite apsilankę **www.nordrive.it** arba tiesiogiai susisiekdami su mūsų vietiniu atstovu.
- PL** Przed użyciem tego produktu prosimy o zapoznanie się z załączoną książeczką bezpieczeństwa i gwarancji. Aby uzyskać więcej informacji, odwiedź **www.nordrive.it** lub skontaktuj się z lokalnym sprzedawcą.
- RUS** Перед использованием продукта ознакомьтесь с буклетом по технике безопасности и гарантией. Для получения дополнительной информации рекомендуем посетить сайт **www.nordrive.it** или обратиться непосредственно к местному дилеру.
- CZ** Před použitím produktu si přečtěte přiloženou bezpečnostní a záruční brožuru. Další informace najdete na **www.nordrive.it** nebo přímo u místního prodejce.
- SK** Pred použitím produktu, prosím naštudujte najprv priložený manuál a bezpečnostné pokyny. Pre viac informácií prosím navštívte **www.nordrive.it** alebo kontaktujte miestneho predajcu/ zástupcu.
- SLO** Pred uporabo proizvoda preberi priložena navodila in garancijsko izjavo. Za več informacij obiščite internetno stran **www.nordrive.it** ali kontaktirajte lokalnega prodajalca.
- HR** Prije uporabe ovog proizvoda, pročitajte priloženo uputstvo o sigurnosti i jamstvu. Za više informacija posjetite **www.nordrive.it** ili kontaktirajte svog lokalnog distributera.
- H** Használat előtt kérjük figyelmesen olvassa el a biztonsági és garanciális útmutatót. Több információért kérjük keresse fel a **www.nordrive.it** weboldalt vagy lépjen kapcsolatba a honi forgalmazóval.
- GR** Πριν χρησιμοποιήσετε το προϊόν, παρακαλούμε διαβάστε το φυλλάδιο ασφάλειας και εγγύησης. Για περισσότερες πληροφορίες, επισκεφθείτε το **www.nordrive.it** ή επικοινωνήστε με τον τοπικό σας αντιπρόσωπο.
- TR** Bu ürünü kullanmadan önce lütfen ekteki güvenli ve garanti kitapçığını okuyun. Daha fazla bilgi için lütfen **www.nordrive.it** adresini ziyaret edin veya yerel bayinizle iletişime geçin.
- BG** Моля преди да използвате този продукт, прочетете инструкциите за безопасност и книжката с гаранционните условия. За повече информация моля посетете **www.nordrive.it** или се свържете с местния дистрибутор.
- SRB** Pre upotrebu ovog proizvoda, pažljivo pročitajte priloženu knjžicu o bezbednosti i garanciji. Za više informacija, molimo vas posetite **www.nordrive.it** ili kontaktirajte lokalnog distributera.



N20011 - Rail Kit Steel
N20012 - Rail Kit Alu

FEET

Contenuto • Content • Contenu • Inhalt • Contenido

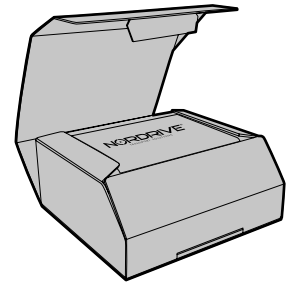

x4

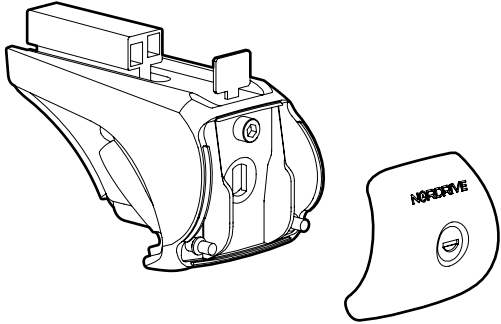

x4

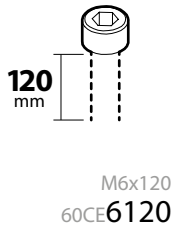

x4

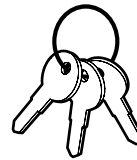

x1

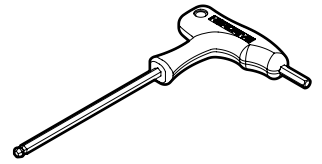

72NA0002



Imballo a parte
Separate pack

BARS

Contenuto • Content • Contenu • Inhalt • Contenido

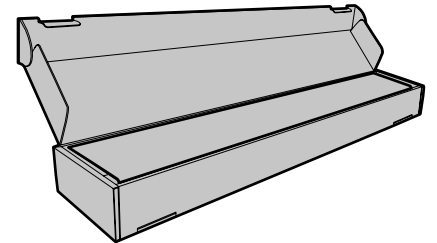

NORDRIVE QUADRA
 Acciaio / Steel



NORDRIVE ALUMIA
 Alluminio / Aluminium

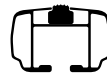

NORDRIVE HELIO
 Alluminio / Aluminium

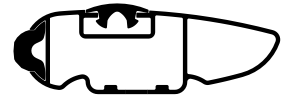

NORDRIVE SILENZIO
 Alluminio / Aluminium

x2

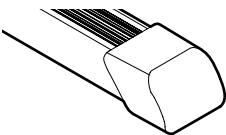

x2

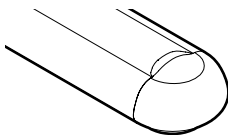

x2

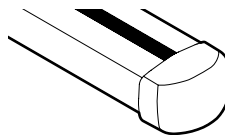

x2

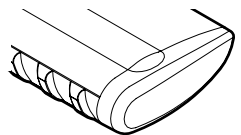

x4

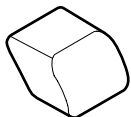

75PL097A

x4



75PL105A

x4



75PL0024

2 + 2

x1

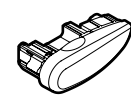

75GR0004
 75GR0005

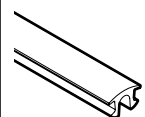

21GO164A

x1

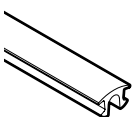

21GO164A

x1

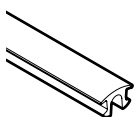

21GO164A

x2



S 21Go0014
M 21Go0001
L 21Go0040
XL 21Go0003

x2



S 21Go0025
M 21Go0026
L 21Go0027
XL 21Go0028

x2



S 21Go0015
M 21Go0016
L 21Go0017
XL 21Go0018

x4



S 21Go0036
M 21Go0037
L 21Go0038
XL 21Go0039

x2



S 21Go0014
M 21Go0001
L 21Go0040
XL 21Go0003



Attenzione • Warning • Attention • Hinweise • Advertencia

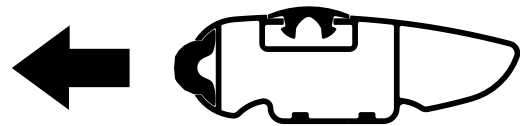
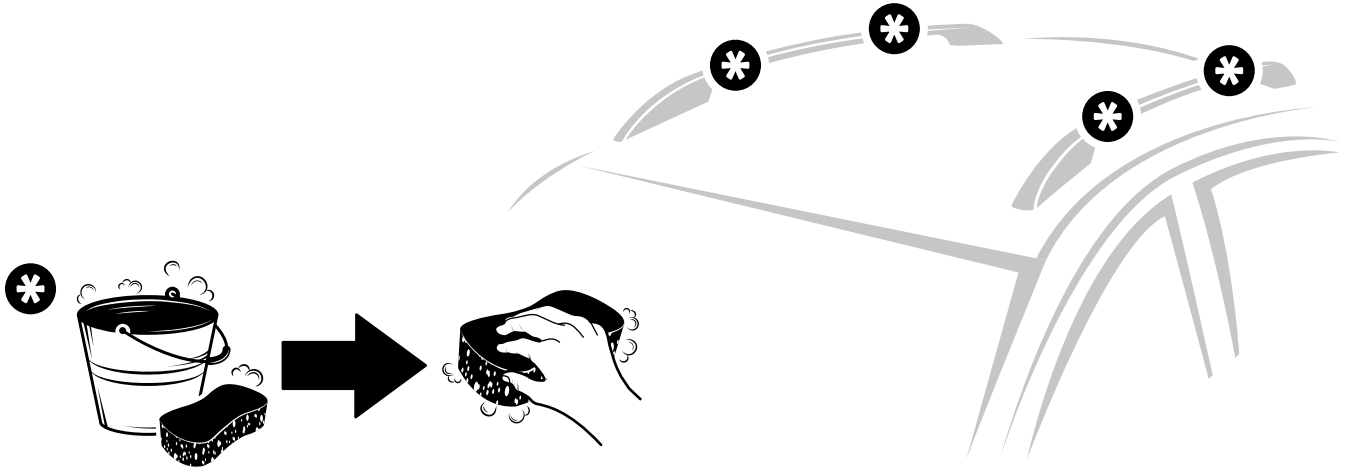

Fronte • Front • Vorderseite



Solo per barre:
Only for bars:
Nur für stangen:

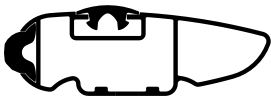
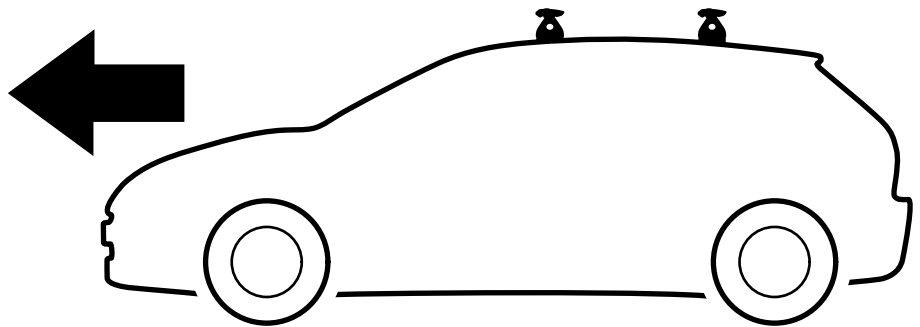

SILENZIO

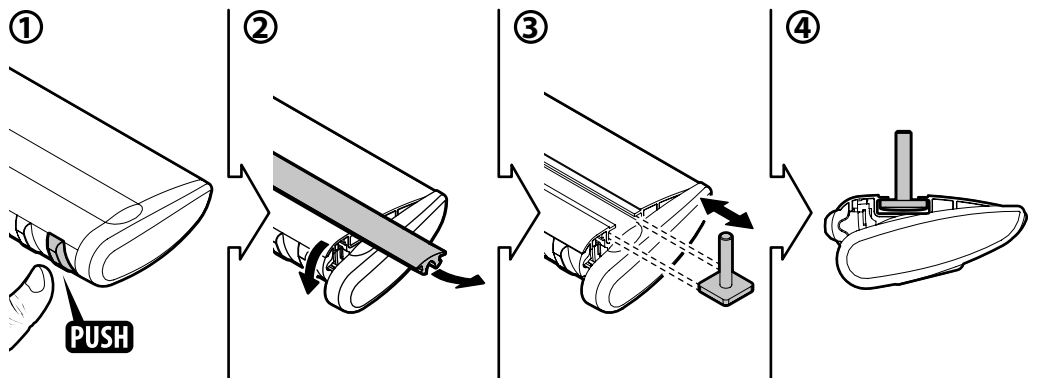



+  x2 =

S	4,9	Kg
M	5,1	Kg
L	5,3	Kg
XL	5,7	Kg

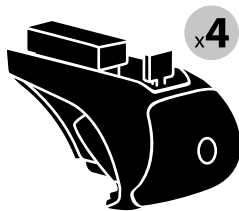

+  x2 =

S	3,5	Kg
M	3,7	Kg
L	3,9	Kg
XL	4,1	Kg

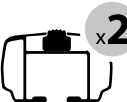
+  x2 =

S	2,9	Kg
M	3,1	Kg
L	3,1	Kg
XL	3,3	Kg

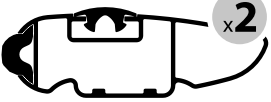
+  x2 =

S	3,7	Kg
M	3,9	Kg
L	4,1	Kg
XL	4,3	Kg

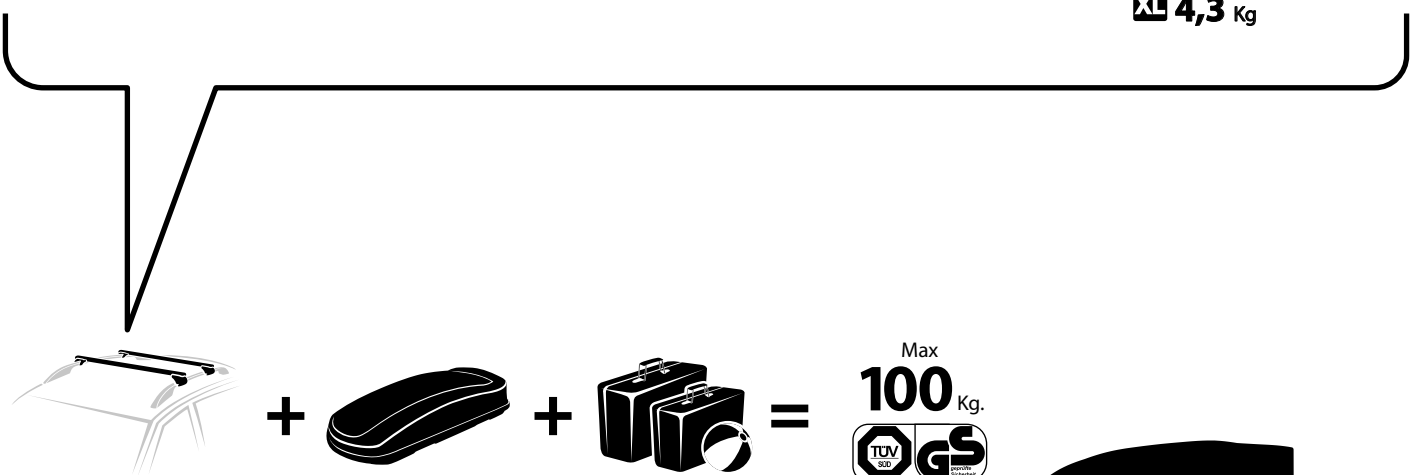

max kg. ??

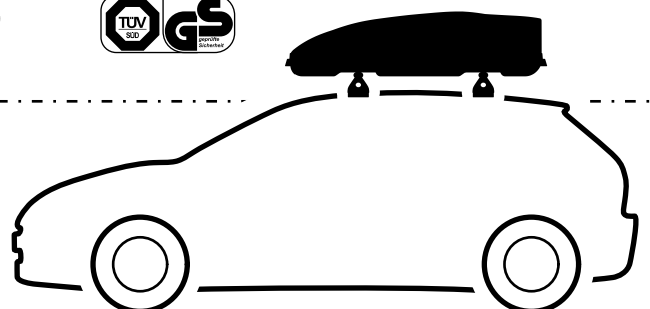

1



NORDRIVE **QUADRA**
Acciaio / Steel

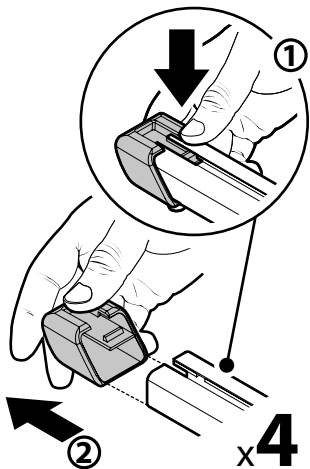

NORDRIVE **ALUMIA**
Alluminio / Aluminium

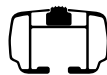
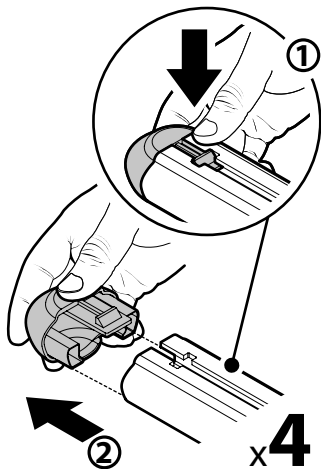

NORDRIVE **HELIO**
Alluminio / Aluminium

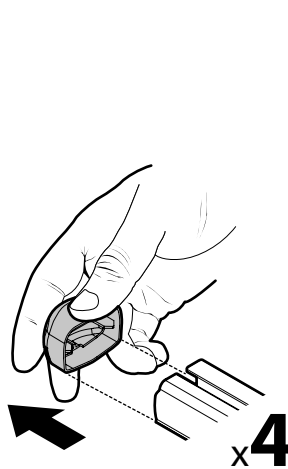

NORDRIVE **SILENZIO**
Alluminio / Aluminium

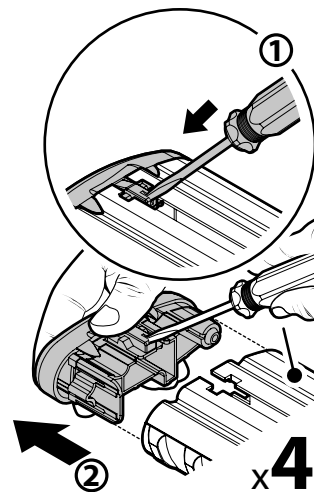

2

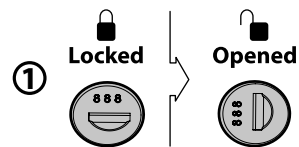
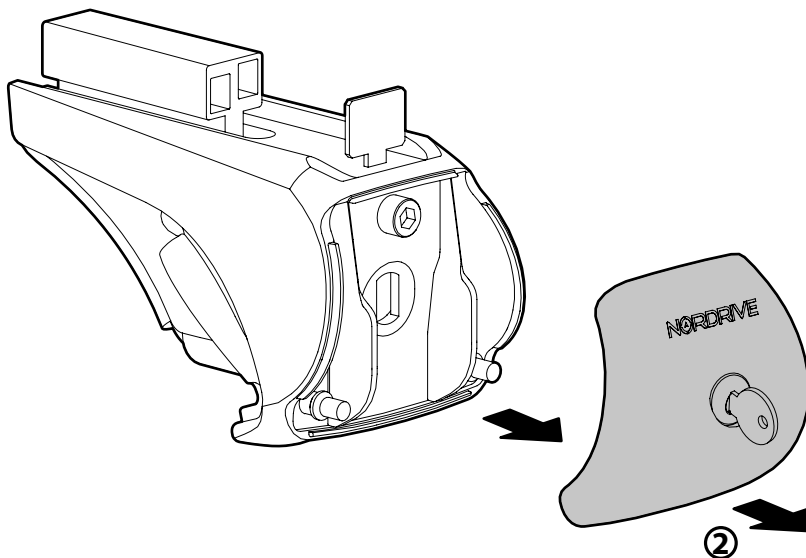

3

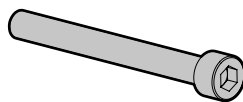
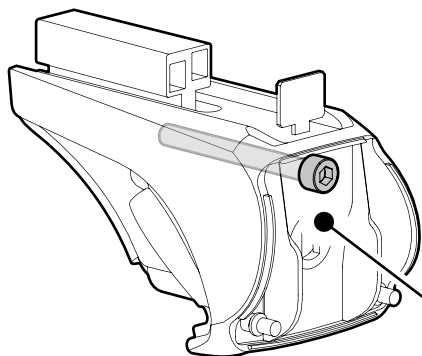

Vite / Screw / Schraube

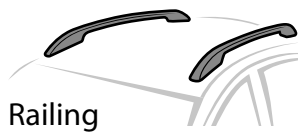

Railing

Preassemblate Pre-assembled Vormontiert	> 100 mm	M6x100 60CE6900	✓	✓	
Include Included Inbegriffen	> 120 mm	M6x120 60CE6120		✓	✓

x4

4

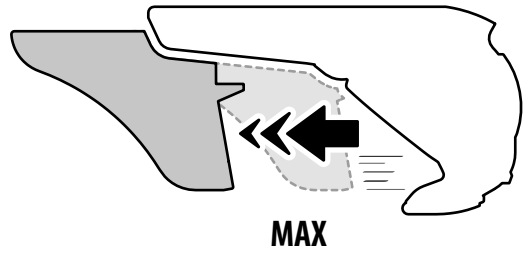
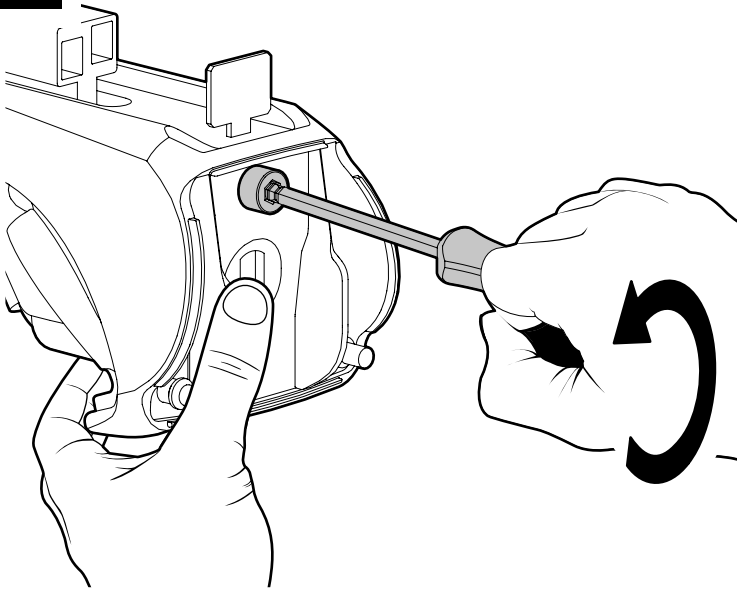

x4

5

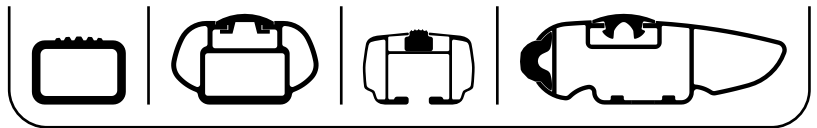
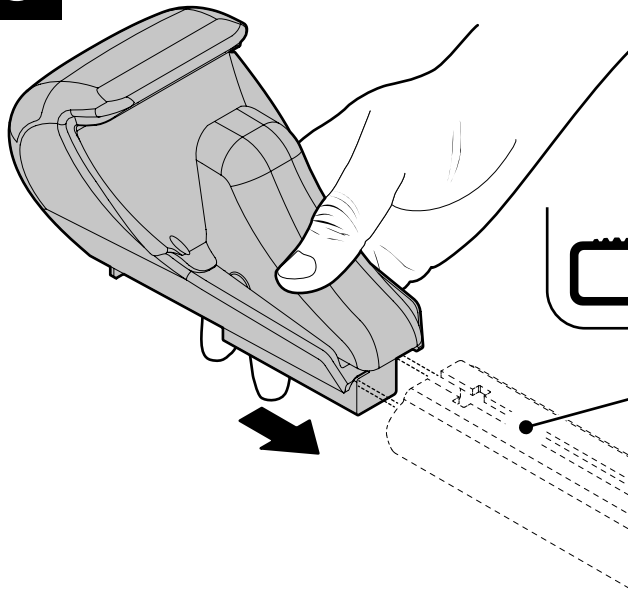

x4

6



NORDRIVE QUADRA
Acciaio / Steel

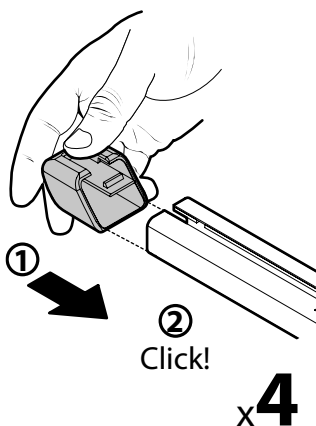

NORDRIVE ALUMIA
Alluminio / Aluminium

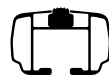
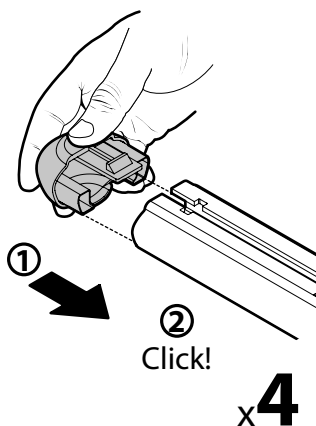

NORDRIVE HELIO
Alluminio / Aluminium

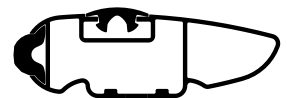
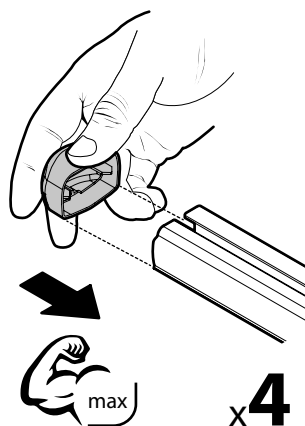

NORDRIVE SILENZIO
Alluminio / Aluminium

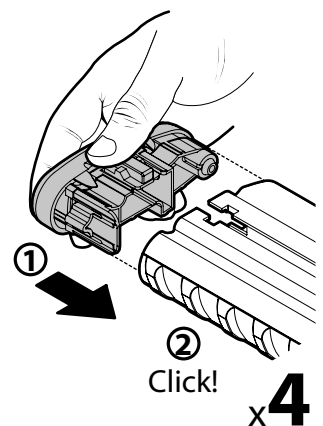

7

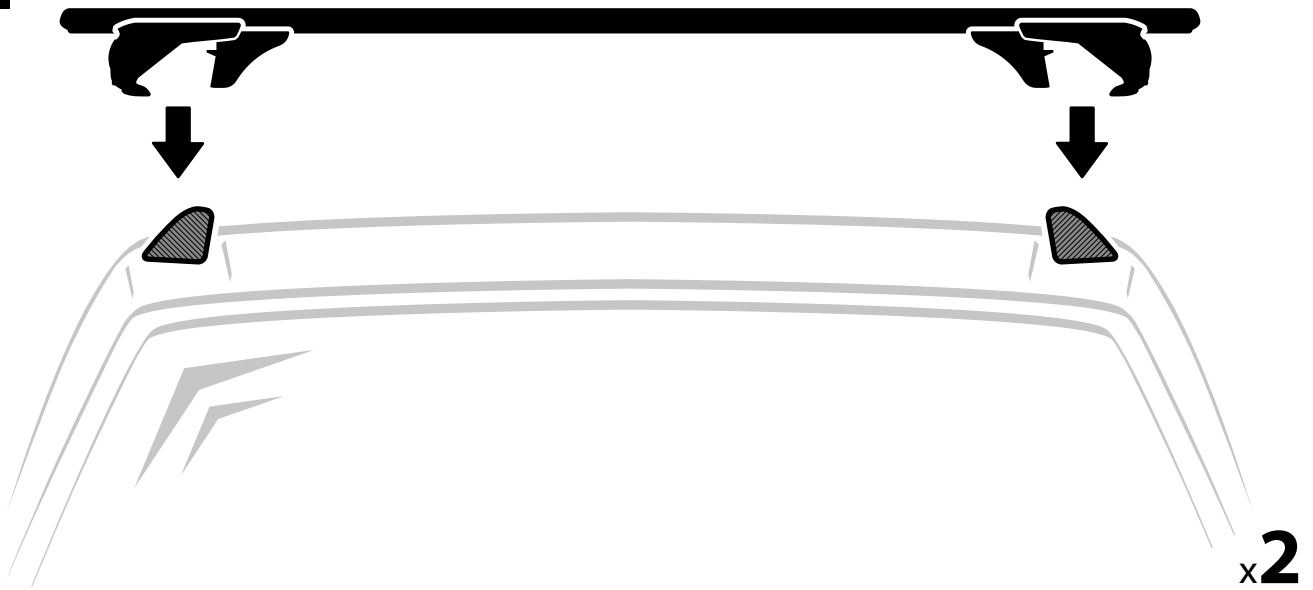

8

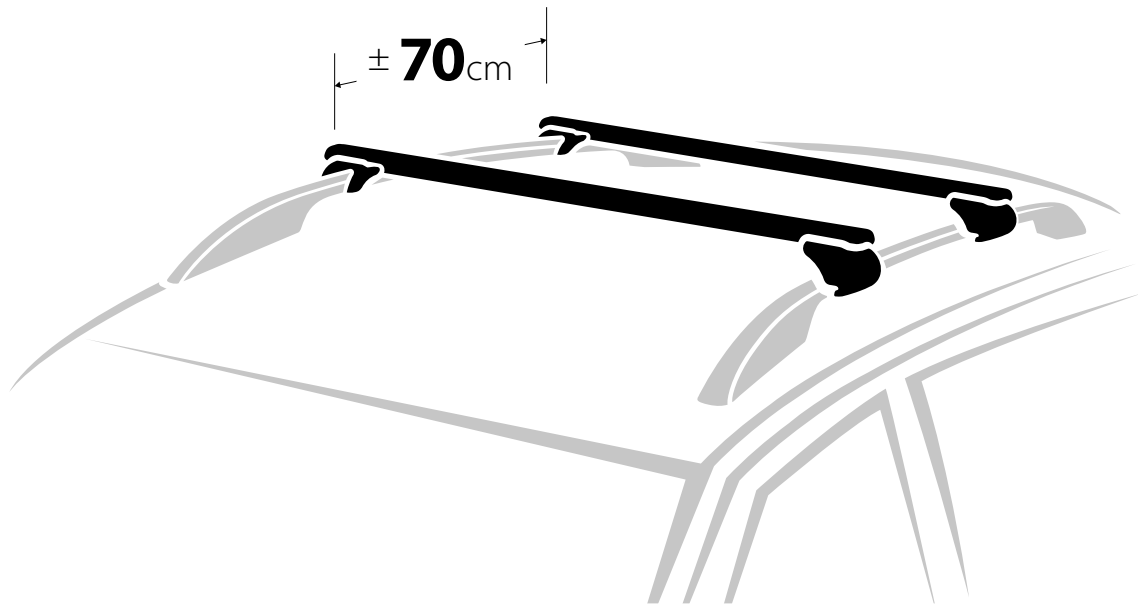

9

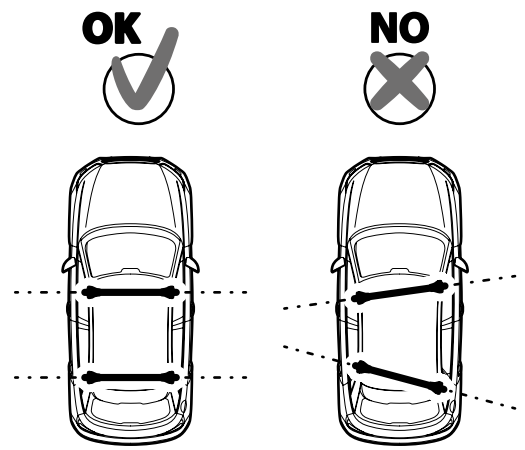
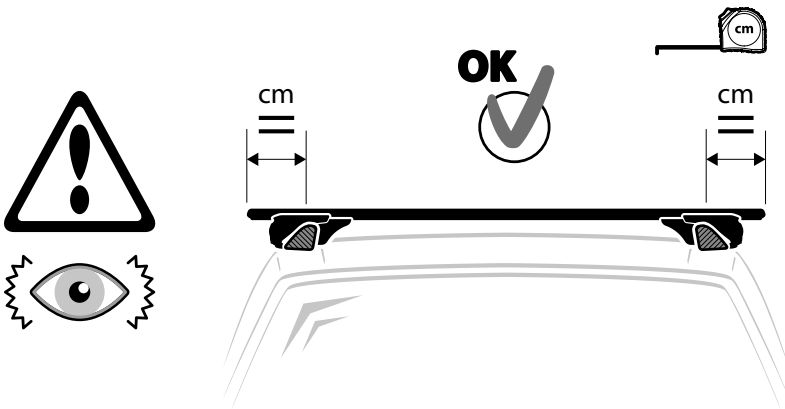

10

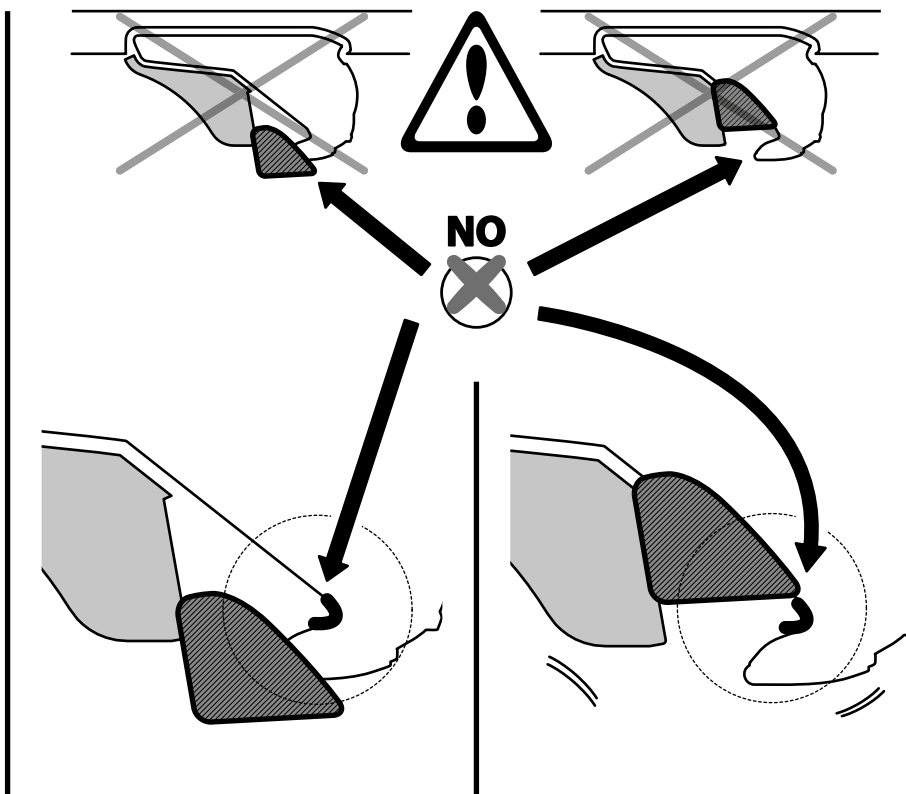
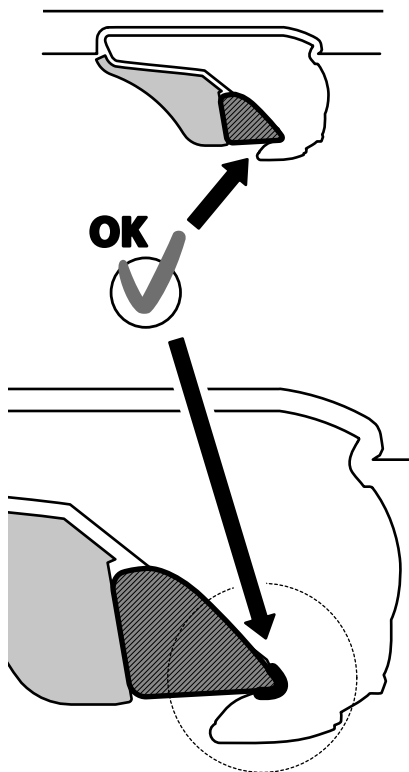
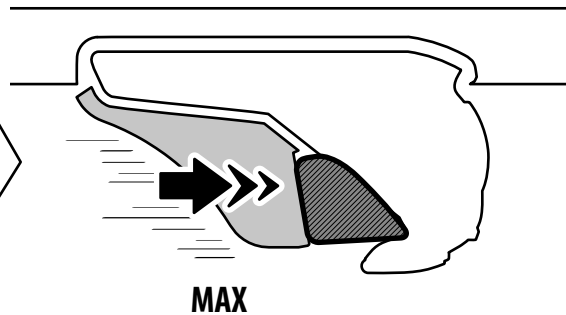
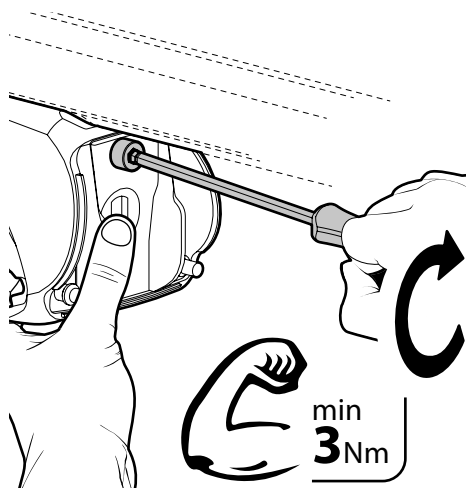
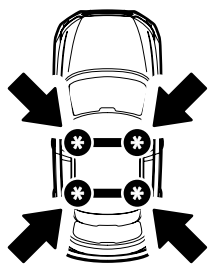

11

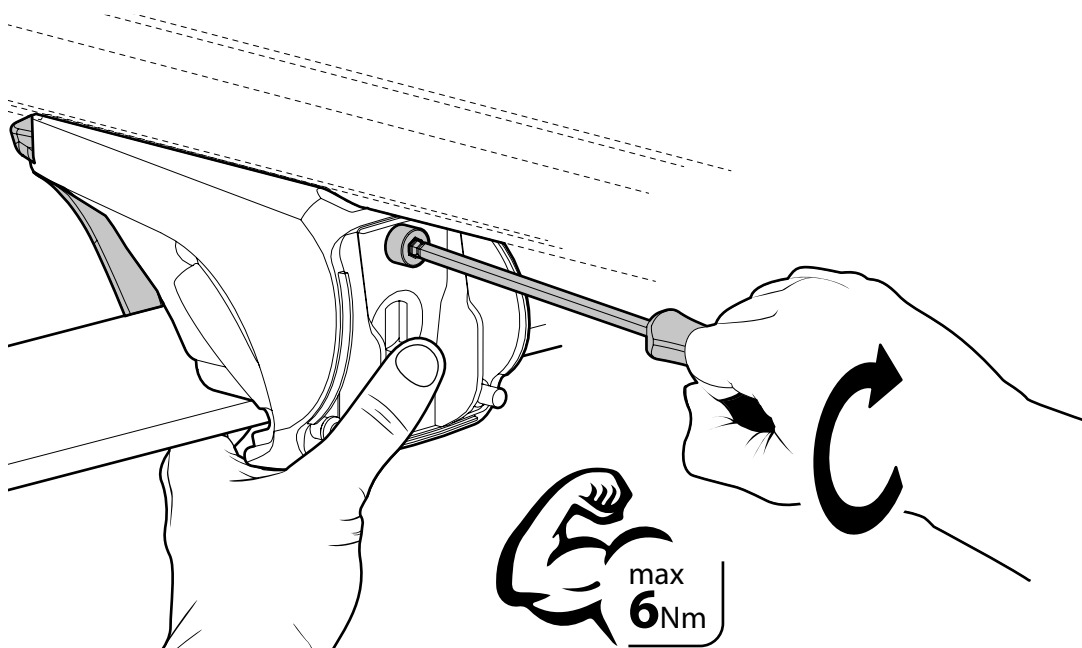
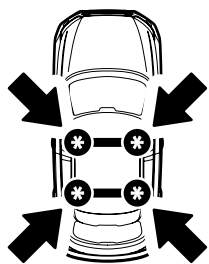

12

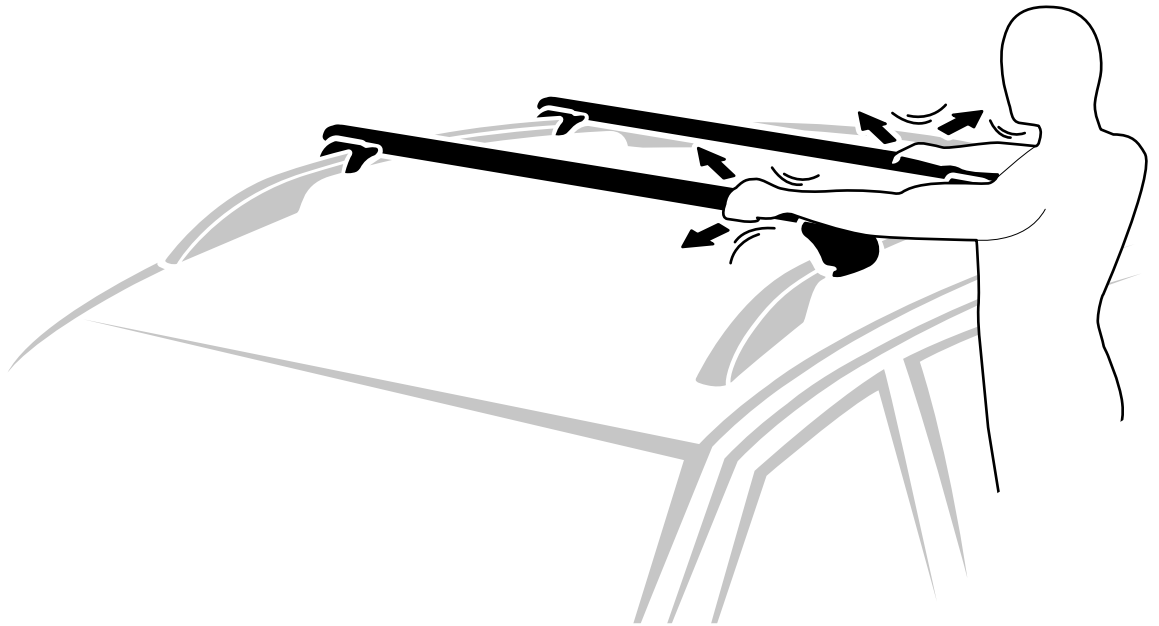

13

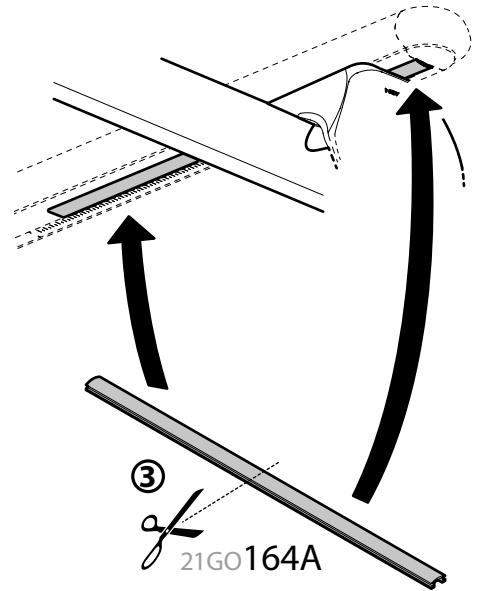
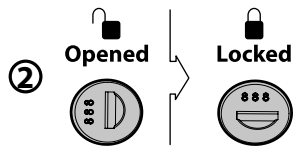
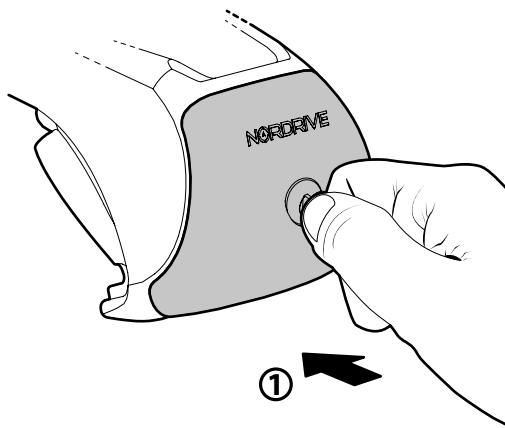
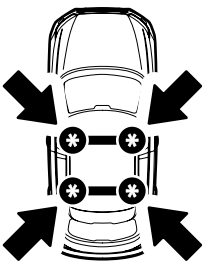



Attenzione • Warning • Attention • Hinweise • Advertencia

0100 Km

Pit-stop / Check!

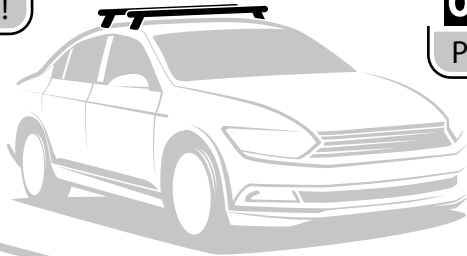

0250 Km

Pit-stop / Check!

0500 Km

Pit-stop / Check!

Pit-stop / Check!

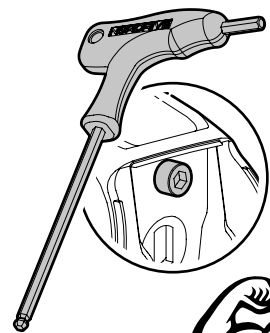
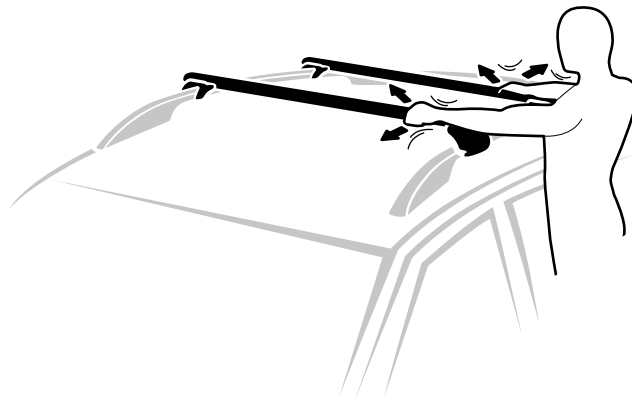

OK

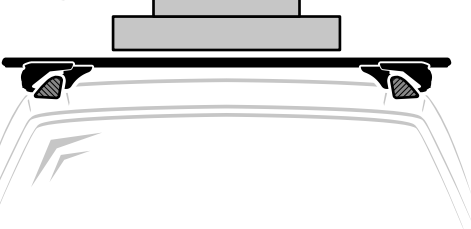

NO

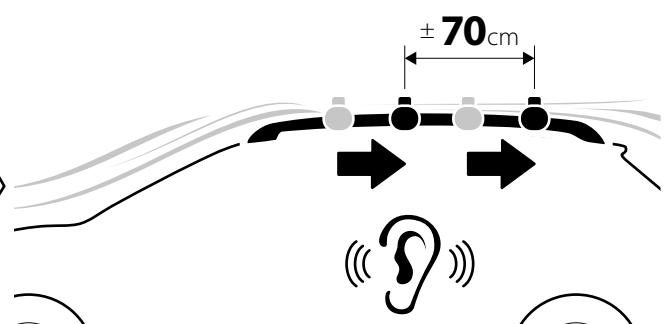
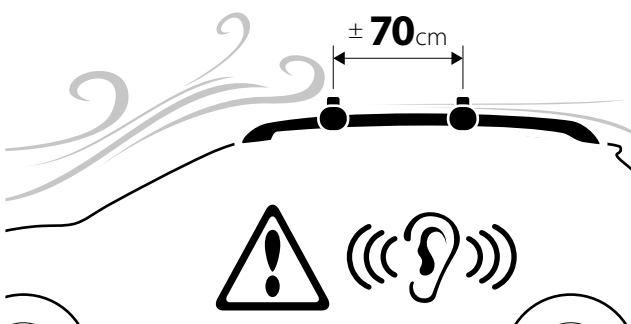
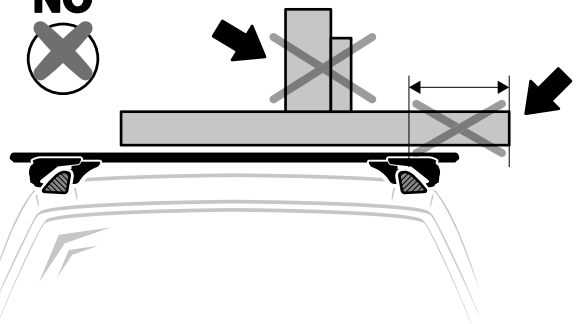



Attenzione • Warning • Attention • Hinweise • Advertencia

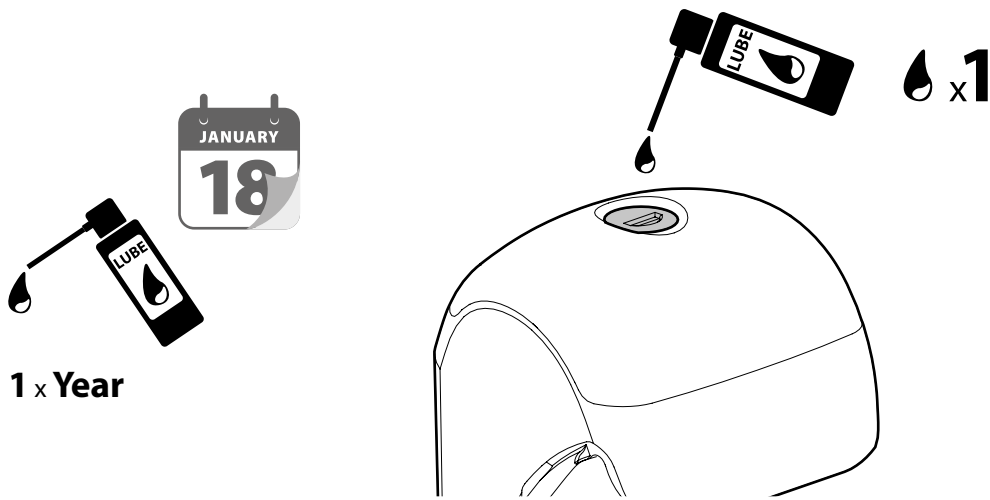
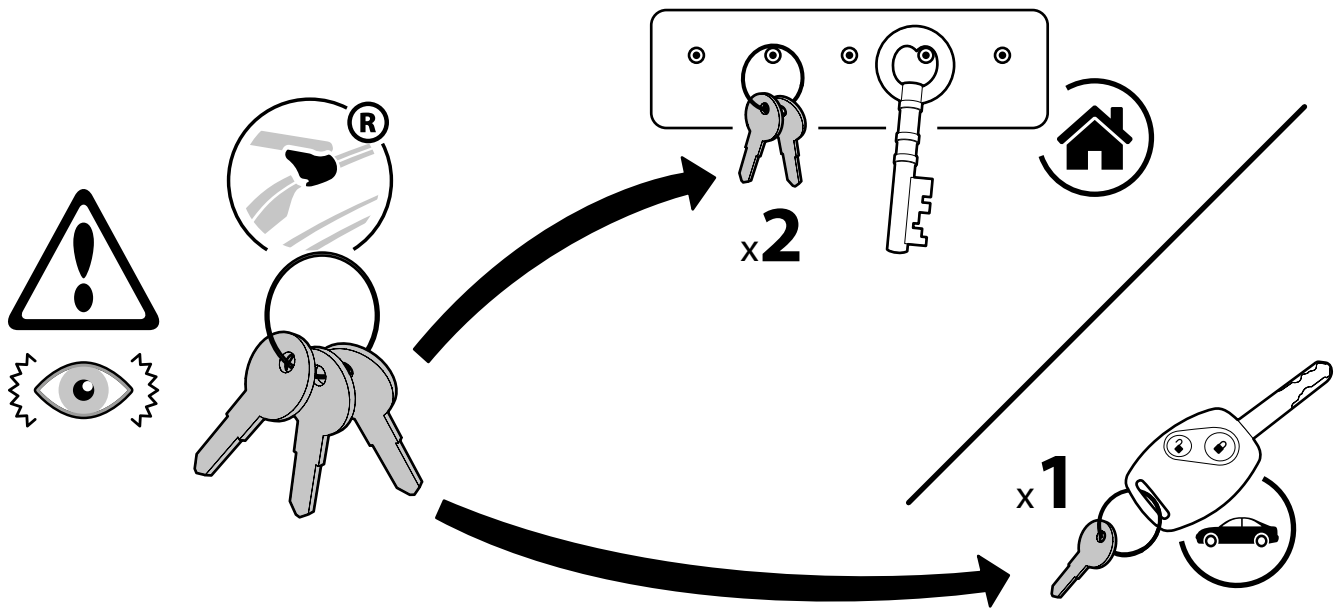

- ① Lotto di produzione da comunicare per eventuali ricambi
- Ⓒ Production lot number to be communicated for any spare parts
- Ⓕ Lot de production à communiquer pour toute pièce de rechange
- Ⓓ Produktionscharge für eventuelle Ersatzteile
- Ⓔ Lote de producción a comunicar por cualquier repuesto

Lot.

NORDRIVE®
TRANSPORT SOLUTIONS

**NORDRIVE® is a registered trademark of
LAMPA S.p.A.**

Via G. Rossa 53/55, 46019 Viadana (MN) ITALY
Tel. +39 0375 820700

UNI EN ISO 9001:2015 Certified Company

www.nordrive.it www.lampa.it

91CA0064 r05