

# Installation Manual

JEEP RENEGADE 5DR  
JEE-RENE-5-A



## COMPONENTS INCLUDED

## SHADES

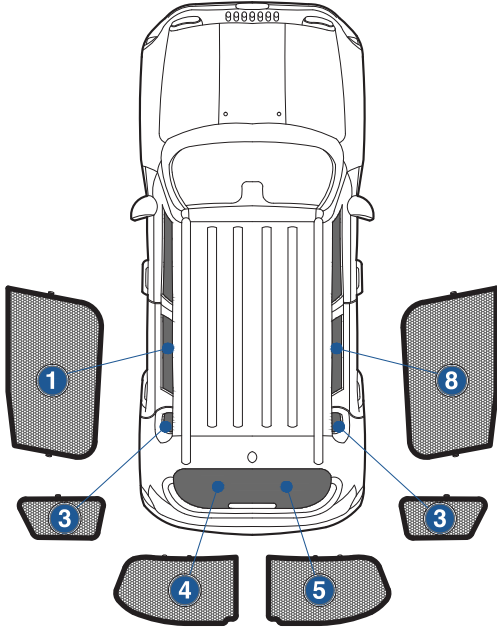

## FIXING CLIPS



CL-M02 x 4



CL-M12 x 2



CL-M05 x 2



CL-M01 x 2



CL-M14 x 1



CL-T01 x 1

# Side Shade Installation

JEEP RENEGADE 5DR  
JEE-RENE-5-A

## COMPONENTS NEEDED:



### STEP #1

INSERT CLIPS INSIDE WEATHERSTRIP



### STEP #2

ATTACH CLIPS ON SHADE EDGES



### STEP #3

POSITION THE SIDE SHADE

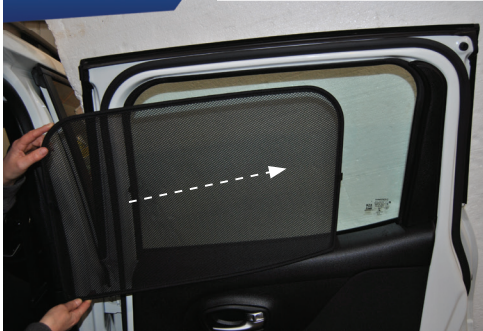

### STEP #4

ATTACH SIDE SHADE BEHIND CLIPS

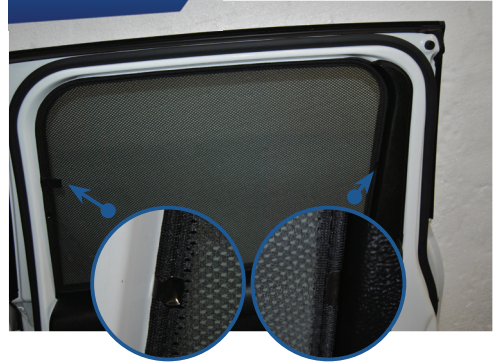

### STEP #5

ENSURE SECURELY FITTED IN PLACE



# Quarter Light Shade Installation

JEEP RENEGADE 5DR  
JEE-RENE-5-A

## COMPONENTS NEEDED:



### STEP #1

ATTACH CLIPS ON SHADE EDGES



### STEP #2

INSERT CLIPS BEHIND INTERIOR TRIM



### STEP #3

ENSURE SECURELY FITTED IN PLACE

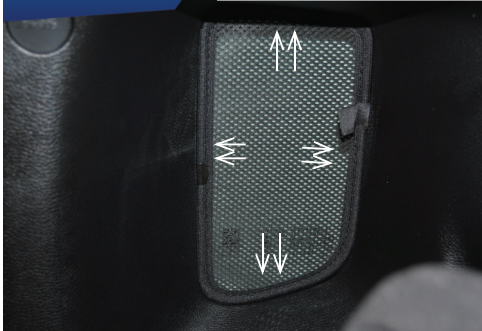

# Rear Shade Installation

JEEP RENEGADE 5DR  
JEE-RENE-5-A

## COMPONENTS NEEDED:

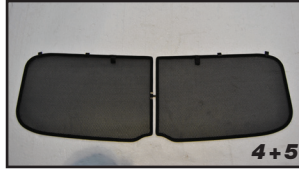

### STEP #1

ATTACH CLIPS ON SHADE EDGES



### STEP #2

POSITION THE REAR SHADE

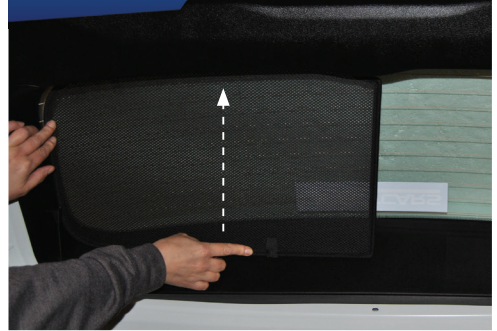

### STEP #3

INSERT CLIPS BEHIND INTERIOR TRIM



### STEP #4

REPEAT THE PROCESS ON OTHER SHADE



### STEP #5

ENSURE SECURELY FITTED IN PLACE

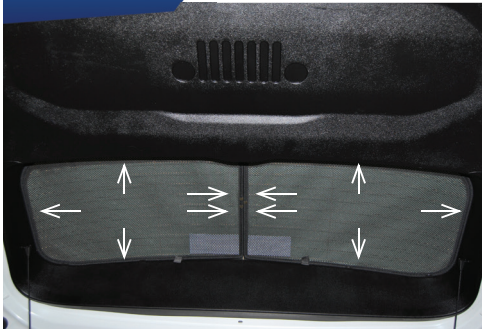

**CAR**  
SHADES